

MODEL	W in[mm]	H in[mm]	X in[mm]	EZ-COIL	1/4" CAPACITY ft[m]	3/8" CAP ft[m]	1/2" CAP ft[m]	3/4" CAP ft[m]	1" CAP ft[m]	WEIGHT lb[kg]
TSH-N-350	9.37 [238]	21.2 [540]	19.5 [495]	Y		50 [15]				55 [25]
TSH-N-375	9.37 [238]	25.5 [648]	24 [435]	Y		75 [23]				73 [33]
TSH-N-3100	9.37 [238]	25.5 [648]	24 [435]	Y		100 [30]				74 [33]
TSH-N-3125	9.37 [238]	25.5 [648]	24 [435]				35 [11]			90 [41]
TSH-N-450	9.37 [238]	21.2 [538]	19.5 [495]	Y			50 [15]			55 [25]
TSH-N-475	9.37 [238]	25.5 [648]	24 [435]	Y			75 [23]			71 [32]
TSH-N-4100	9.37 [238]	25.5 [648]	24 [435]	Y			100 [30]			80 [36]
TSH-N-535	9.87 [251]	25.5 [648]	24 [435]	Y				35 [11]		67 [30]
TSH-N-550	9.87 [250]	25.5 [648]	24 [435]	Y				50 [15]		70 [32]
TSH-N-575	12 [305]	25.5 [648]	24 [435]					75 [23]		73 [34]
TSH-N-635	10 [254]	25.5 [648]	24 [435]						35 [11]	71 [32]
TSH-N-650	12 [305]	25.5 [648]	24 [435]						50 [15]	77 [35]
TMP-N-350	9.37 [238]	21.2 [538]	19.5 [495]	Y		50 [15]				61 [28]
TMP-N-375	9.37 [238]	25.5 [648]	24 [435]	Y		75 [23]				80 [36]
TMP-N-3100	9.37 [238]	25.5 [648]	24 [435]			100 [30]				82 [37]
TMP-N-450	9.37 [238]	21.2 [538]	19.5 [495]	Y			50 [15]			64 [29]
TMP-N-475	9.37 [238]	25.5 [648]	24 [435]	Y			75 [23]			80 [36]
TMP-N-4100	9.37 [238]	25.5 [648]	24 [435]				100 [30]			80 [36]
TMP-N-525	9.87 [250]	21.9 [555]	20.4 [517]					25 [7.6]		57 [26]
TMP-N-535	9.87 [250]	25.5 [648]	24 [435]					35 [11]		74 [33]
TMP-N-550	9.87 [250]	25.5 [648]	24 [435]	Y				50 [15]		74 [33]
TMP-N-575	12.5 [317]	25.5 [648]	24 [435]					75 [23]		77 [35]
TMP-N-650	12.5 [317]	25.5 [648]	24 [435]						50 [15]	81 [37]
THP-N-150	9.37 [238]	21.2 [540]	19.5 [495]	Y	50 [15]					62 [29]
THP-N-175	9.37 [238]	25.5 [648]	24 [435]	Y	75 [23]					71 [32]
THP-N-1100	9.37 [238]	25.5 [648]	24 [435]	Y	100 [30]					82 [37]
THP-N-350	9.37 [238]	21.2 [504]	19.5 [495]	Y		50 [15]				66 [30]
THP-N-375	9.37 [238]	25.5 [648]	24 [435]	Y		75 [53]				80 [36]

UNLISTED OPTIONS & CUSTOM REELS
 NOT ALL OPTIONS ARE LISTED. CONTACT YOUR SALES REPRESENTATIVE OR FACTORY FOR ADDITIONAL OPTIONS & CUSTOM MODIFICATIONS

SPECIFICATIONS		
FEATURE	SPEC.	OPTION
PRESSURE	SEE PAGE 2	-
TEMPERATURE	SEE PAGE 2	-
INLET THREAD	NPT FEMALE	BSP
OUTLET THREAD	NPT MALE	BSP

MATERIAL SPECIFICATIONS		
COMPONENT	MATERIAL	OPTIONS
SWIVEL	BRASS (1/4" - 3/4")	STAINLESS STEEL (3/8"-1") ZINC PLATED ON HP
SEALS	NITRILE	VITON, EPDM, FOOD, AFLAS
REEL	STEEL	STAINLESS STEEL
BEARINGS	BRONZE, SELF LUBE	-
BALL STOP	RUBBER	-
LOCKING PAWL	STAINLESS STEEL	BRONZE (NON-SPARK)
FINISH	BLUE POWDER COAT (B)	RED(R), GREEN(N), WHITE(W), BLACK [WRINKLE(C)/GLOSS(K)], GREY(G) POLISHED STAINLESS (SS)

COXREELS
 5865 S Ash Avenue Tempe, Az 85283
 1-800-COX-REEL www.coxreels.com
 THIS DOCUMENT CONTAINS PROPRIETARY INFORMATION AND IS THE PROPERTY OF COXREELS, INC. THE COPYING, DISTRIBUTION AND UTILIZATION OF THIS DOCUMENT AS WELL AS COMMUNICATION OF ITS CONTENT TO OTHERS WITHOUT THE WRITTEN AUTHORIZATION OF COXREELS, INC., IS PROHIBITED.

TITLE: T (TSH, TDMP) SERIES		
DWG. NO.:	T SERIES	REV. -
3RD ANGLE	INTERPERT PER ASME : Y14.5M-1994 DO NOT SCALE DWG.	SIZE: A SHT:1 OF: 2

in[mm]

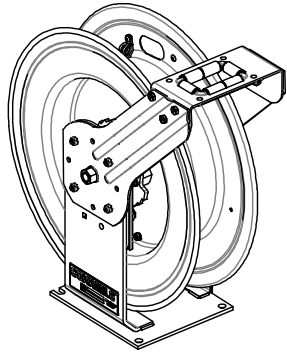

FLOOR- CEILING MOUNT
(STANDARD CONFIG (-X))

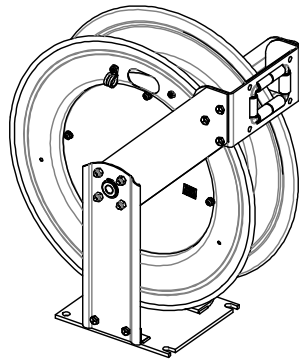

WALL- TRUCK MOUNT (-W)

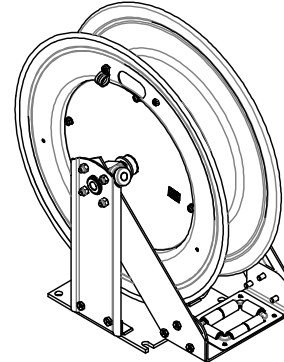

DOWN MOUNT (-D)

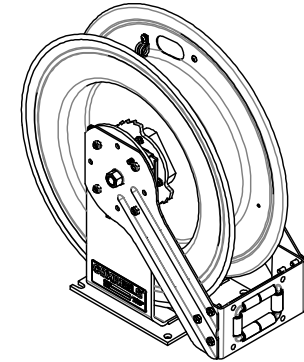

BOTTOM- TRUCK MOUNT (-B)

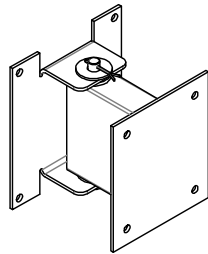

SWING BRACKET
- VERTICAL SURFACE MOUNT
- 180 DEGREE OF TRAVEL
- P/N 15725

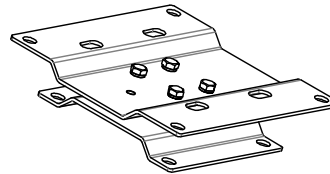

SWIVEL BRACKET
- HORIZONTAL MOUNT
- 345° ROTATION
- NOT FOR CEILING MOUNT!
- P/N 15721

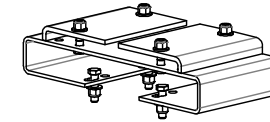

OVERHEAD MOUNT
- 3" TO 8.5" FLANGE
- I OR H BEAM APPLICATION
- P/N MRT-1

STANDARD HOSES:

TYPE	SIZE	COLOR	COVER	TUBE	REINFORCEMENT	PRESSURE	TEMP RANGE
LP	1/4" TO 1/2"	RED	PVC	PVC	YARN	300 PSI	-15 TO +150 F
MP	3/8"	BLACK	SYNTHETIC RUBBER	POLYESTER	1 BRAID STEEL WIRE	3000 PSI	-40 TO +250 F
MP	1/2"	BLACK	SYNTHETIC RUBBER	POLYESTER	1 BRAID STEEL WIRE	2500 PSI	-40 TO +250 F
HP	1/4"	BLACK	SYNTHETIC RUBBER	POLYESTER	2 BRAID STEEL WIRE	5000 PSI	-40 TO +250 F
HP	3/8"	BLACK	SYNTHETIC RUBBER	POLYESTER	2 BRAID STEEL WIRE	4000 PSI	-40 TO +250 F

OPTIONAL HOSES (LP ONLY):

SUFFIX	SIZE	COLOR	COVER	TUBE	REINFORCEMENT	PRESSURE	TEMP RANGE
OG	1/4" TO 1/2"	BLACK	NEOPRENE	NITRILE	2 TEXTILE SPIRAL	300 PSI	-20 TO +212 F
RH	1/4" TO 1/2"	RED	EPDM	EPDM	2 TEXTILE SPIRAL	300 PSI	-40 TO +212 F
BH	1/4" TO 1/2"	BLACK	EPDM	EPDM	2 TEXTILE SPIRAL	300 PSI	-40 TO +212 F
BP	1/4" TO 1/2"	BLUE	PVC	PVC	YARN	300 PSI	-15 TO +150 F
YP	1/4" TO 1/2"	YELLOW	PVC	PVC	YARN	300 PSI	-15 TO +150 F

MISC OPTIONS (MOST COMMON):

B= BEND RESTRICTOR (LIMITS DEGREE OF BEND, PREVENTS PREMATURE HOSE END FAILURE)

C= CONSTANT TENSION (NO LOCKING FEATURE WHEN EXTENDED)

R= REVERSE CONFIGURATION (MECHANISMS REVERSED TO ALLOW SIDE-BY-SIDE MOUNTING)

N= NON-SPARKING (BRONZE CONTACT PARTS, SPARK PROOF FOR EXPLOSIVE ENVIROMENTS)

*EZ= EZ-COIL RETRACTION REDUCTION DEVICE (UP TO 80% SLOWER RETRACTION)

PART NUMBER

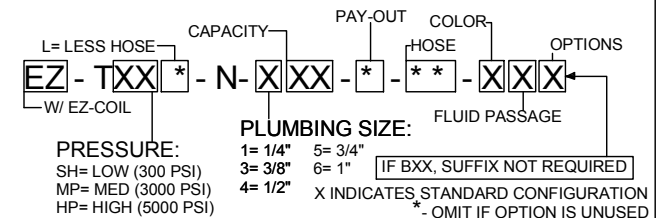

COXREELS
 5865 S Ash Avenue Tempe, Az 85283
 1-800-COX-REEL www.coxreels.com
 THIS DOCUMENT CONTAINS PROPRIETARY INFORMATION AND IS THE PROPERTY OF COXREELS, INC. THE COPYING, DISTRIBUTION AND UTILIZATION OF THIS DOCUMENT AS WELL AS COMMUNICATION OF ITS CONTENT TO OTHERS WITHOUT THE WRITTEN AUTHORIZATION OF COXREELS, INC., IS PROHIBITED.

TITLE: T (TSH, TDMP) SERIES	
DWG. NO.:	REV.
T SERIES	-
3RD ANGLE	INTERPERT PER ASME : Y14.5M-1994 DO NOT SCALE DWG.
SIZE: A	SHT:2 OF: 2